

# TYPICAL SECTIONS FOR PREFERRED ALTERNATIVE (ALTERNATE 5A)

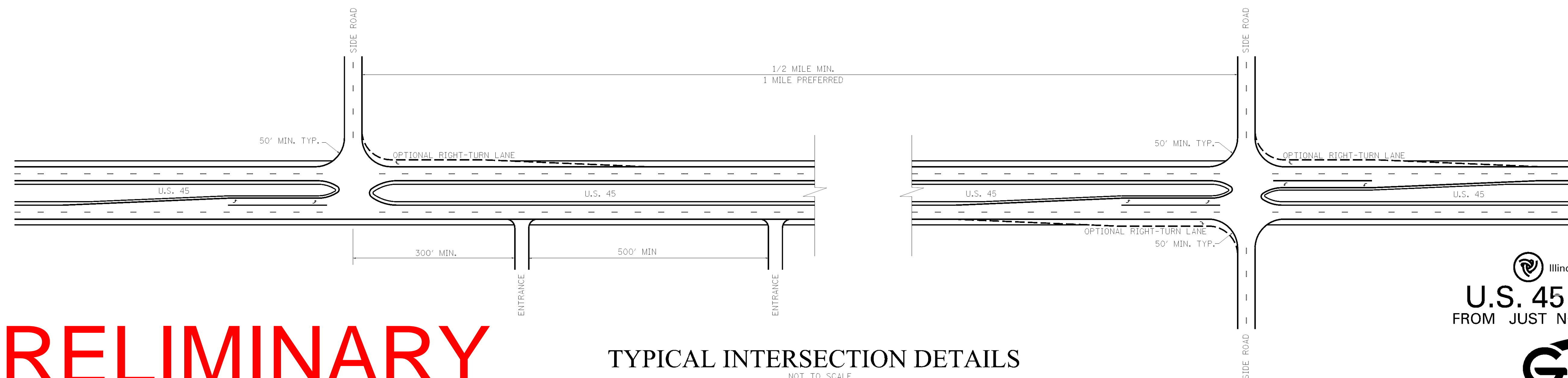

Illinois Department of Transportation  
**U.S. 45 EXPANSION**  
 FROM JUST NORTH OF IL 142 TO IL 141

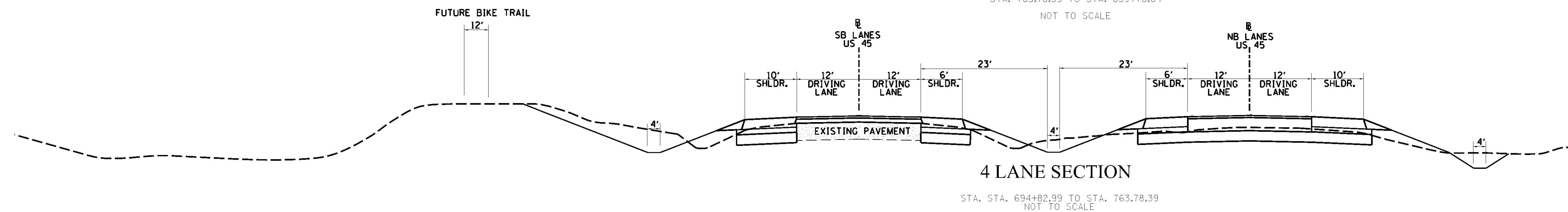
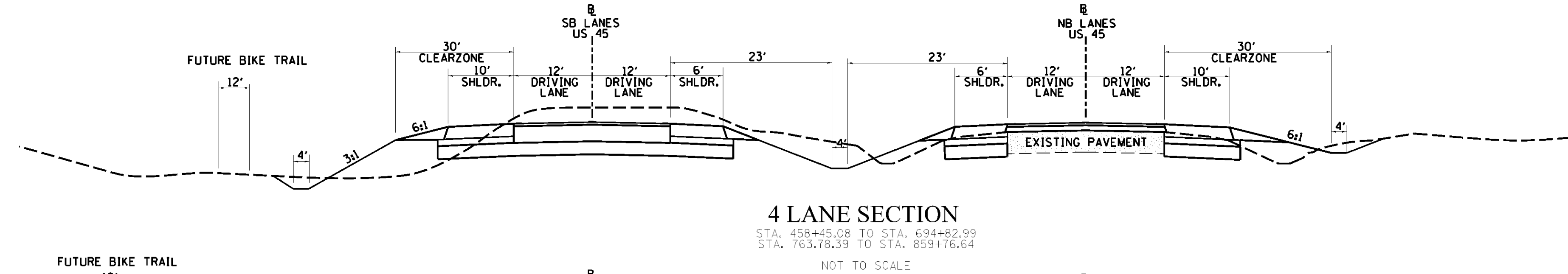
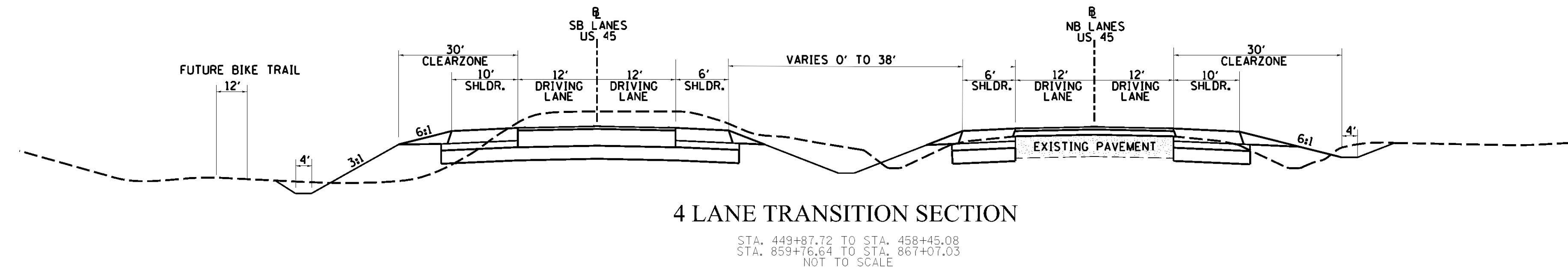
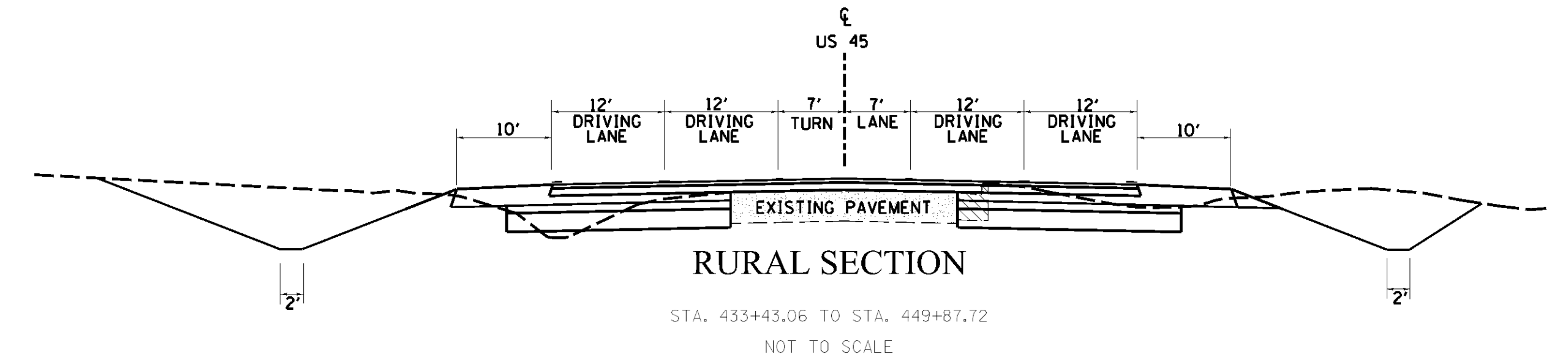
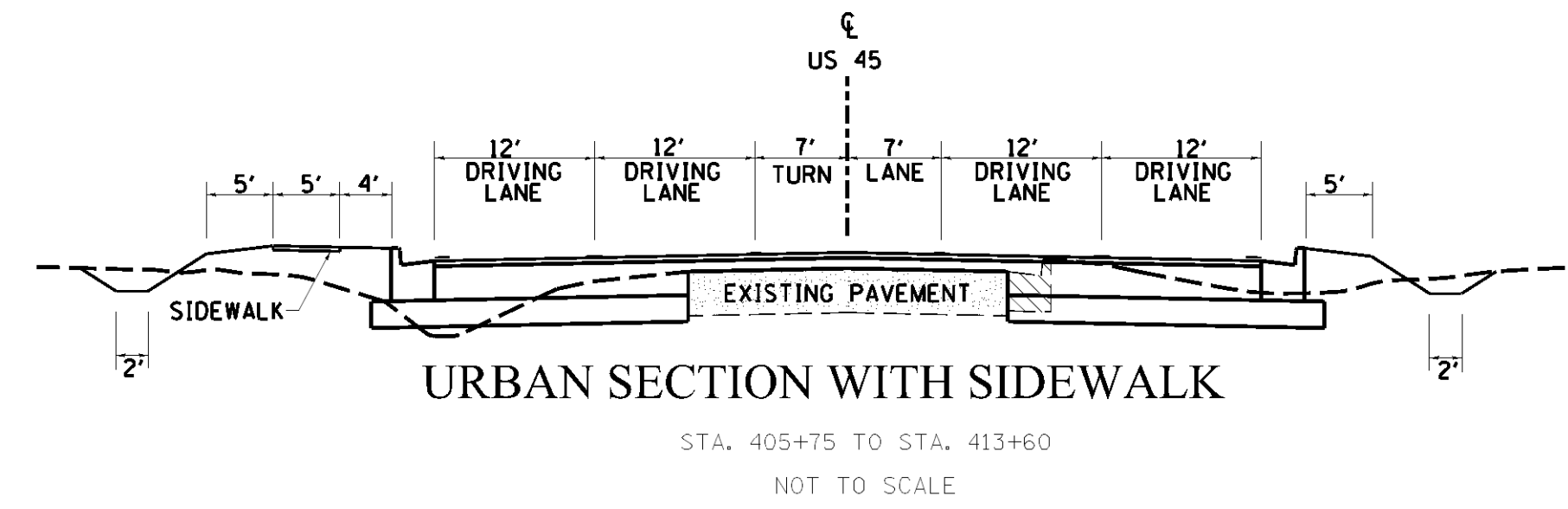
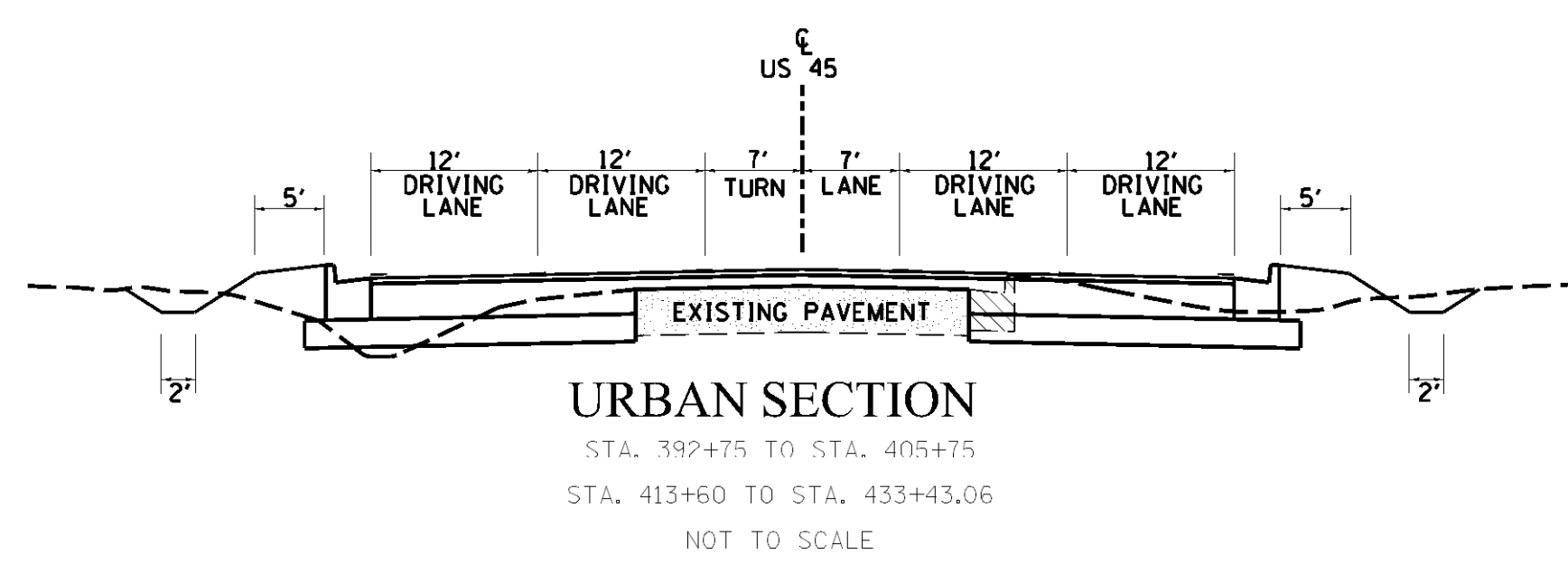

601 NORTH 4th STREET MURRAY, KENTUCKY 42071  
 500 SOUTH 17th STREET PADUCAH, KENTUCKY 42003  
 403 NORTH COURT STREET MARION, ILLINOIS 62959  
 PHONE - 270.753.7307 PHONE - 270.443.1995 PHONE - 618.997.9196

**PRELIMINARY**